

600mm Suspended Slimline Double Door Basin Unit With Ceramic Basin

Double Door
Basin Unit
600

Buying code: NLSL6BUDDOS (+ Colour code)



Diagrams not to scale.
All dimensions in mm tolerance of +/- 2mm

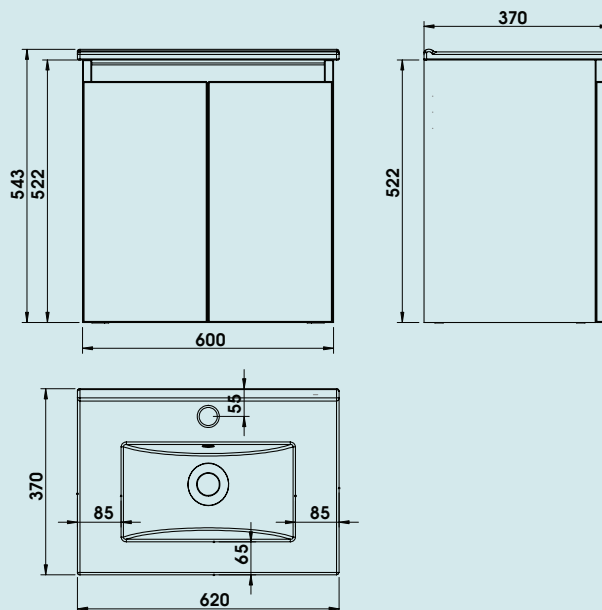

Specification:

- Available in 5 contemporary finishes
- Matching cabinet internals
- Exquisitely finished fascias & cabinet sides
- Pull to open soft-close doors
- Easy to adjust doors
- Ceramic basin
- Decorative aluminium top rail

Introducing the Newland Modular range - a sleek, contemporary unit that effortlessly combines form and function. With its striking design and attention to detail, this beautiful modular unit not only brings style and storage to any bathroom but also enhances the overall ambience. Elevate your bathroom to new heights of sophistication with the Newland Modular range.

Finish Options:

Internal Cabinet Finish | Matches External



White
Gloss



Sage Green
Matt



Pearl Grey
Matt



Midnight Mist
Matt



Natural Oak
Matt

Colour Code:

66

87

04

67

14

Door Style Options:



Newland

Unit Weight:	23.1kg
Depth of unit with doors open:	620mm
Width of unit with doors open:	740mm

95% of packaging is recyclable
Check local recycling info for correct disposal