

NAP BSM C

NAPOLI Tap Range Napoli Bath Shower Mixer Chrome



Features:

- Long life 1/4 turn ceramic disc valves for added durability and smooth control.
- Robust metal fixing nut to secure the tap in place reducing the risk of loosening over time.
- Rub clean handset - limescale and debris build-up is quickly and easily removed by rubbing a finger or a cloth over the nozzles.
- A hard-wearing, flawless, scratch resistant chrome finish that lasts for years. Salt spray tested to ensure added durability.
- 10-year parts and 1 year labour guarantee for peace of mind.
- Co-ordinating Bathroom taps available.

Product Certifications:



Specification

Product Type:	Bathroom Taps
Main Construction Material:	Brass
Mount Type:	Deck
Handle Type:	Lever
Connection Inlet:	3/4" BSP
Connection Outlet:	M24 Recessed Aerator
Number of Tap Holes:	2
Valve/Cartridge Type:	3/4" Ceramic Disc Valve
Plumbing System Requirements:	Suitable for all plumbing systems
Minimum Dynamic Pressure (bar):	0.2 bar
Maximum Dynamic Pressure (bar):	5 bar
Maximum Hot Water Temperature °C:	60°C
Maximum Static Pressure (bar):	10 bar
Flow Type:	Single
Isolation Included:	No

Dimensions (measurements in mm)

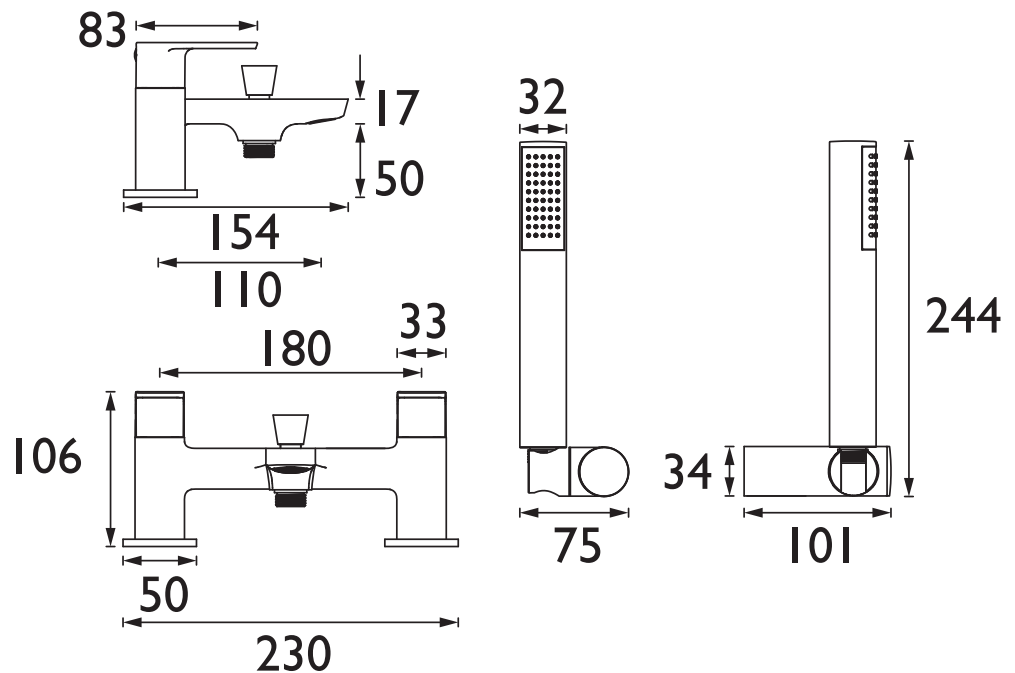

Flow Rates (l/min)

System Pressure (bar)	0.2	0.5	1	2	3	5
Through Bath Filler (mixed)	12.6	20.4	29.6	41.8	51.2	66
Through Handset (mixed)	4	6.7	9.6	14.1	18.4	23.8

TECHNICAL
DATA
SHEET



BRISTAN

D3